

Sprinter Data



Team Introductions



Dylan Cedeno
Project Manager
Presenter



Marc Griffiths
Design Engineer
Presenter



Jordan Noyes
Quality Engineer



Handy A Pierre
Research Engineer



Edwin Ulysse
Data Engineer

Sponsor and Advisor

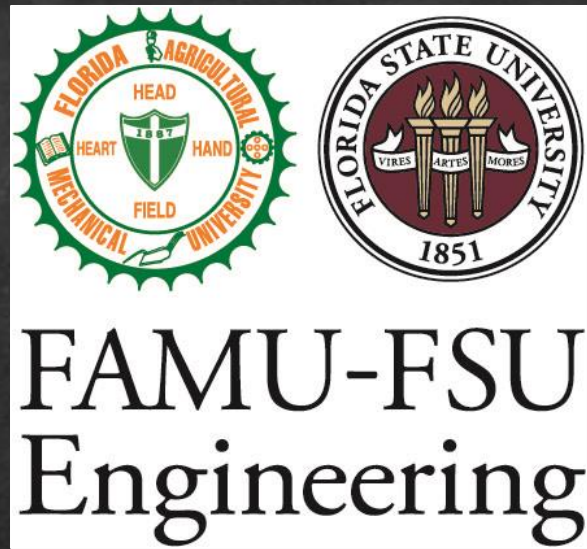

Sponsor

FAMU-FSU College of Engineering
Academic Institution



Academic Advisor

Jonathon Clark, Ph.D.
Associate Professor

Dylan Cedeno

Summarizing DR4

Dylan Cedenno



Objective



The objective of this project is to create a desirable product that will objectively measure and predict a sprinter's performance.

Dylan Cedeno

Launch Monitor Pro Overview



Dylan Cedeno

Base Station Details

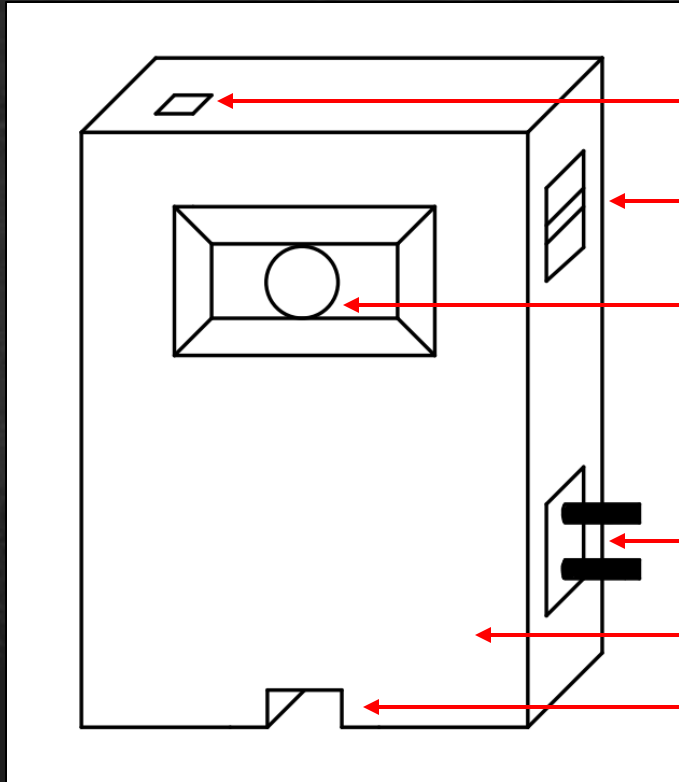

Laptop Connection

Carrying Handle

High-Speed Camera

External Connections for Sensors

Battery Housing

Alignment Tool for Starting Line

Dylan Cedeno

InNOLEvation Challenge



The InNOLEvation Process



✚ Applied for the competition



✚ Competed against other entrepreneurial groups

- ✚ Business pitch
- ✚ Market research

✚ Made it through the first rounds to the semi-finals



✚ Attempted to proceed to finals

Dylan Cedeno

Why Did We Lose?

Market Size

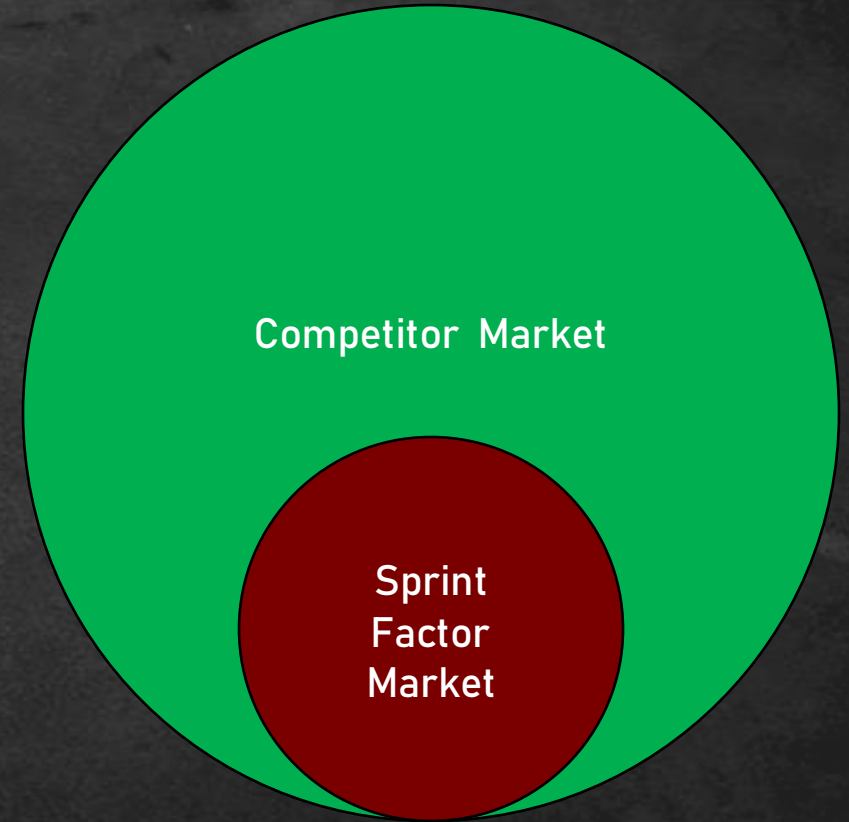

Dylan Cedeno

What Did We Learn?

- ✚ Need a plan to expand to larger markets
- ✚ More about the business approach to design
 - ✚ Less technical explanation
 - ✚ More focus on finances
- ✚ Ways to expand market research

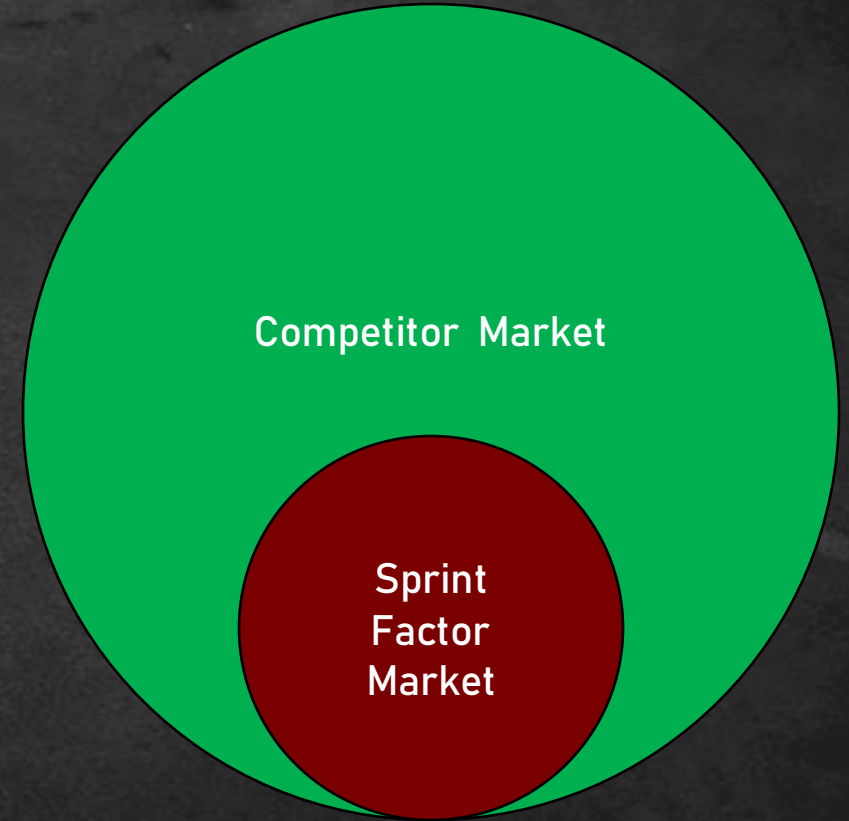

Dylan Cedeno

CAD Model



Detailed CAD Model – Modular Base Station

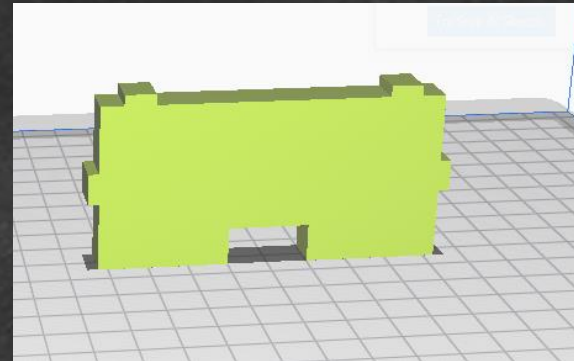
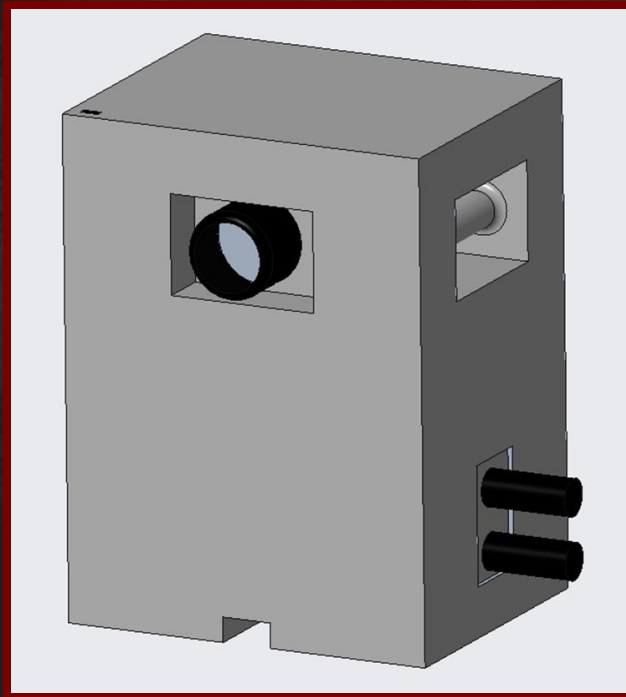

Top

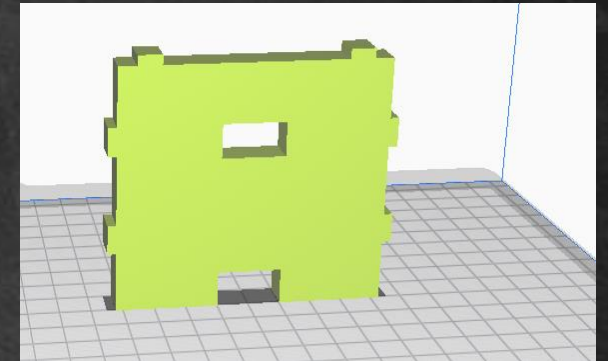

Front

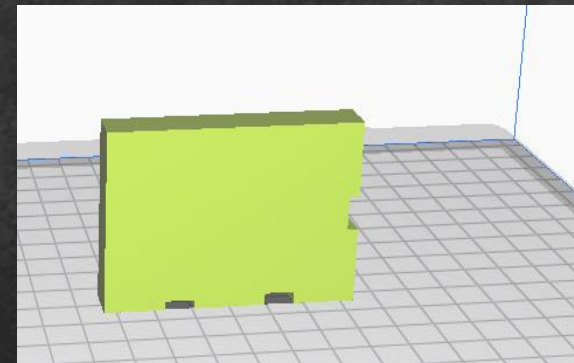

Side

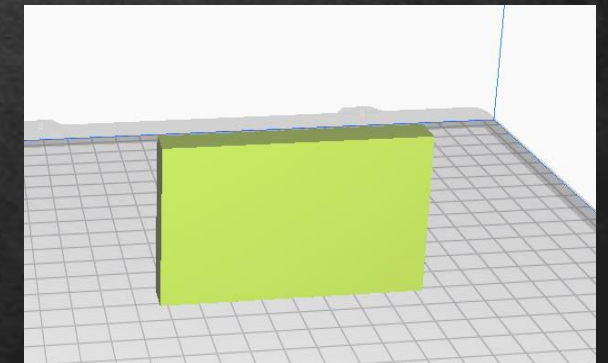

Shelf

Dylan Cedeno

Purchasing Parts

Parts Purchased and Parts on Hold

Marc Griffiths



High Speed Camera

✚ Description: MaxxMove Rize H4
4K Action Camera (Black)

✚ Unit Price: \$93.79

✚ Quantity: 1



Marc Griffiths

Force Sensors

✚ Description: SENSOR FORCE
LOAD CELL 500LBS

✚ Unit Price : \$140.45

✚ Quantity: 1



Marc Griffiths

Measuring Tape

✚ Description: 15 m Fiberglass
Metric Long Tape Measure,
Pumpkin

✚ Unit Price : \$20.42

✚ Quantity: 1



Marc Griffiths

Housing Sensor Connectors

✚ Description: QWIIC CABLE –
500MM

✚ Unit Price : \$2.19

✚ Quantity: 10

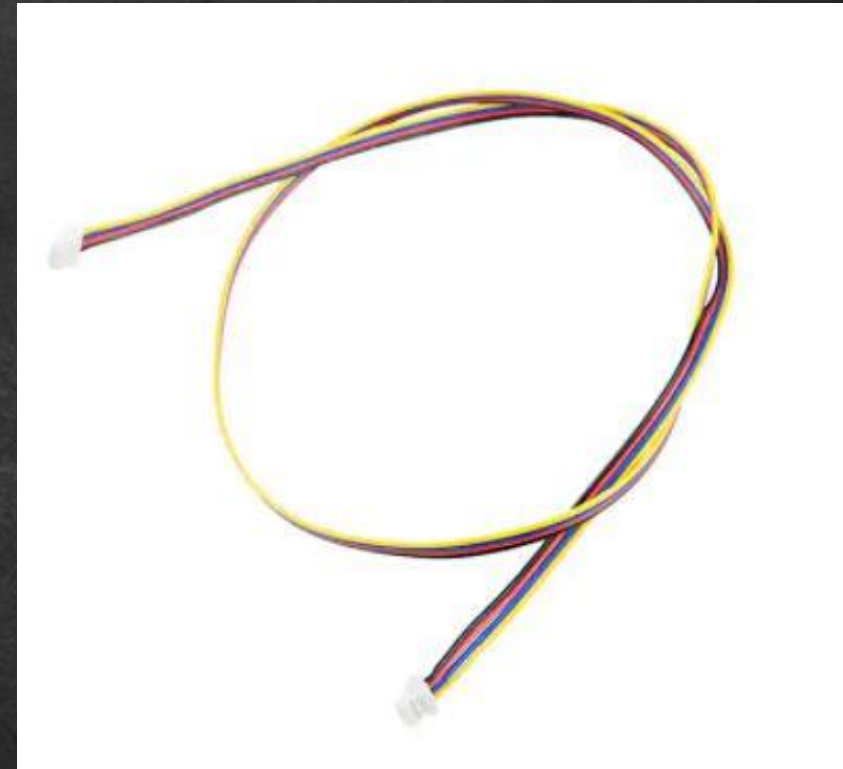

Marc Griffiths

Audio Recorder

✚ OMNI-DIRECTIONAL
MICROPHONE -50D

✚ Unit Price : \$1.45

✚ Quantity: 10



Marc Griffiths

Battery Pack

✚ Description: Acellories
10,000mAh Power Badge Power
Bank (Black)

✚ Unit Price : \$14.99

✚ Quantity: 1



Marc Griffiths

USB Extender

✚ Description: 1m Extension USB Cable, A Male to A Female, Black

✚ Unit Price : \$2.99

✚ Quantity: 1



Marc Griffiths

Internal Wiring

- ✦ Description: JUMPER WIRE M/M
6" 20PCS
- ✦ Unit Price : \$1.95
- ✦ Quantity: 1 pack (20 wires)

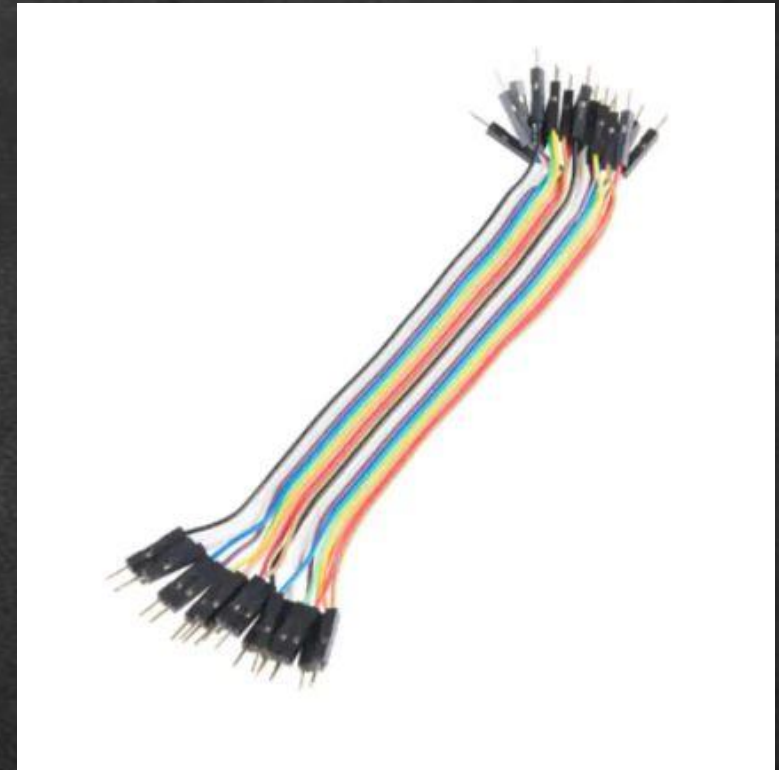

Marc Griffiths

Parts on Hold

Expensive parts that need further analysis and assistance

- ✦ Dots
- ✦ Infrared sensors
- ✦ On board processor
- ✦ External wires
- ✦ Software

Marc Griffiths

Future Work



What's Next...

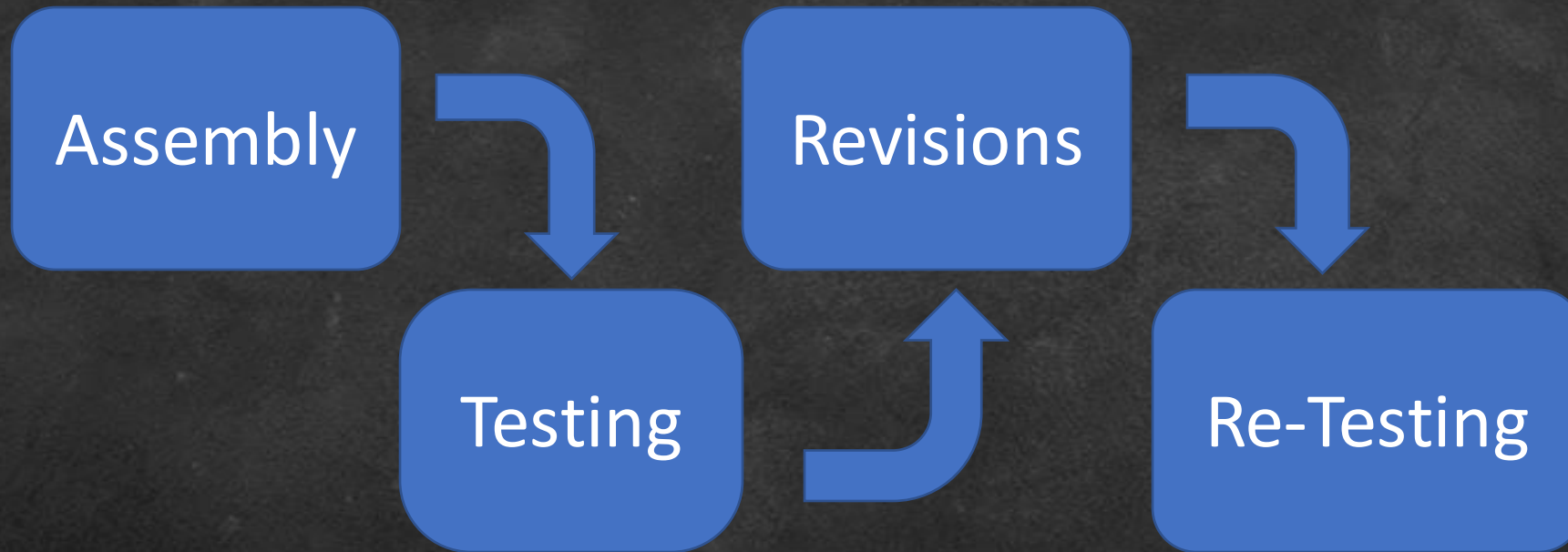

Marc Griffiths

Assembly

- ✈ Code for machine learning software
- ✈ Load code onto on board processor
- ✈ Splice & solder wires
- ✈ Check for general functionality

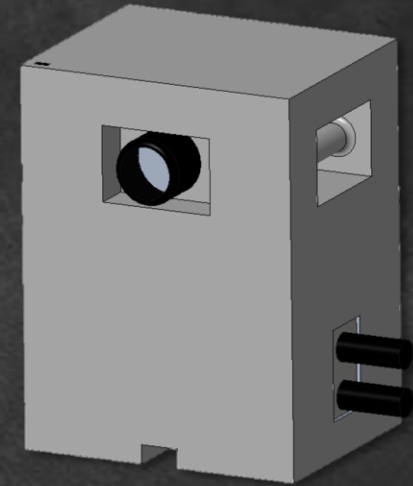

Marc Griffiths

Testing

- ✎ Group will test it
 - ✎ No unnecessary forms for volunteers
- ✎ Stress Test
 - ✎ Test every worst-case scenario
- ✎ Make sure every function works



Marc Griffiths

Revisions

✚ Use what was learned during the testing stage

✚ Adjust for errors with hardware

✚ Revise code



✚ Revisit the functionality and mobility of the base station

Marc Griffiths

Re-Testing

- ✎ Test the fixes that were made
- ✎ Find additional problem areas
- ✎ Redesign if necessary
- ✎ Finalize the Launch Monitor Pro



Marc Griffiths

Thank You for Listening!

Our mission is to utilize technology to enhance the performance of athletes and help them maximize their full potential.



References

- <https://simplifaster.com/articles/contact-length-sprinting-speed/>
- <https://www.robotshop.com/en/gravity-adjustable-infrared-sensor-switch-0-200cm.html>
- <https://www.uline.com/Product/Detail/S-11441G/Inventory-Labels/Removable-Adhesive-Circle-Labels-Fluorescent-Green-1>
- <https://www.readymaderc.com/products/details/runcam-2-orange>
- https://www.mouser.com/ProductDetail/Measurement-Specialties/FC2331-0000-0250-L?qs=%2Fha2pyFaduJAcSl6CN5plYO6WA8FlwYq8JSEgUbhuaTLavI4ZQOcpKAymRqJ4p0X&utm_source=octopart&utm_medium=aggregator&utm_campaign=824-FC2331-00000250L&utm_content=TE%20Connectivity&tetid=R9TeESmvAY
- <http://ontrackandfield.com/measuring-tape-komelon-fiberglass-open-reel/>
- <https://www.dataversity.net/what-is-data-storage/>
- <https://www.google.com/imgres?imgurl=https%3A%2F%2F3dprintingforbeginners.com%2Fwp-content%2Fuploads%2F2013%2F02%2FABS-Filament-Spools.jpg&imgrefurl=https%3A%2F%2F3dprintingforbeginners.com%2Ffilamentprimer%2F&tbid=B6ovlHCFOxhioM&vet=12ahUKewjdsJbJn6nuAhXJQUIHHTuHCc8QMygBegUIARDsAQ..i&docid=RcLAbEe3kgxRfM&w=625&h=375&q=3d%20printing%20material&ved=2ahUKewjdsJbJn6nuAhXJQUIHHTuHCc8QMygBegUIARDsAQ>
- <https://www.sparkfun.com/products/8733>
- <https://www.ametron.com/samson-go-mic-direct-portable-usb-microphone-with-noise-cancellation-technology>
- https://www.te.com/usa-en/product-6364372-2.html?te_bu=Cor&te_type=srch&te_campaign=ggl_usa_cor-ggl-usa-srch-selectmktg-fy21-googlefeed_sma_sma-1735_94&elqCampaignId=95278&mkwid=mobaVbvD%7Cpcrid%7C386964346943%7Cpkw%7C%7Cpmt%7C%7Cpdv%7C%7Cslid%7C%7Cproductid%7C6364372-2%7Cpgrid%7C78782457763%7Cptaid%7Cpla-1016296564002%7C&utm_content=mobaVbvD%7Cpcrid%7C386964346943%7Cpkw%7C%7Cpmt%7C%7Cpdv%7C%7Cslid%7C%7Cproductid%7C6364372-2%7Cpgrid%7C78782457763%7Cptaid%7Cpla-1016296564002&gclid=Cj0KCQiAkuP9BRcKARIsAKGLE8UM9pHmNco6CE0eNi2BBOQUnXQjsORumOzOVN4a0Bjew_HK-VBMHmcaAgo7EALw_wcB



References

- https://www.bhphotovideo.com/c/product/1267710-REG/maxxmove_mxm_ac_rizeh4_b_rize_h4_4k_action.html
- <https://www.digikey.com/en/products/detail/te-connectivity-measurement-specialties/FC2311-0000-0500-L/809399>
- <https://www.grainger.com/product/KESON-15-m-Fiberglass-Metric-Long-3LJW8>
- <https://www.digikey.com/en/products/detail/sparkfun-electronics/PRT-14429/7652742>
- <https://www.digikey.com/en/products/detail/pui-audio-inc/TOW-3050P-B-R/9744554>
- https://www.bhphotovideo.com/c/product/1462220-REG/acellories_pb500_b_10_000_mah_power_bank.html?sts=pi&pim=Y
- <https://www.grainger.com/product/MONOPRICE-3-ft-Extension-USB-Cable-5XGA4>
- <https://www.digikey.com/en/products/detail/sparkfun-electronics/PRT-12795/5993860>

Backup Slides



Market Size

- **TAM** Total Available Market
- **SAM** Serviceable Available Market
- **SOM** Serviceable Obtainable Market

<https://www.ncaa.org/about/resources/research/estimated-probability-competing-college-athletics>

<https://askwonder.com/research/globally-people-practice-running-as-sport-global-market-size-sport-dba00dqv>

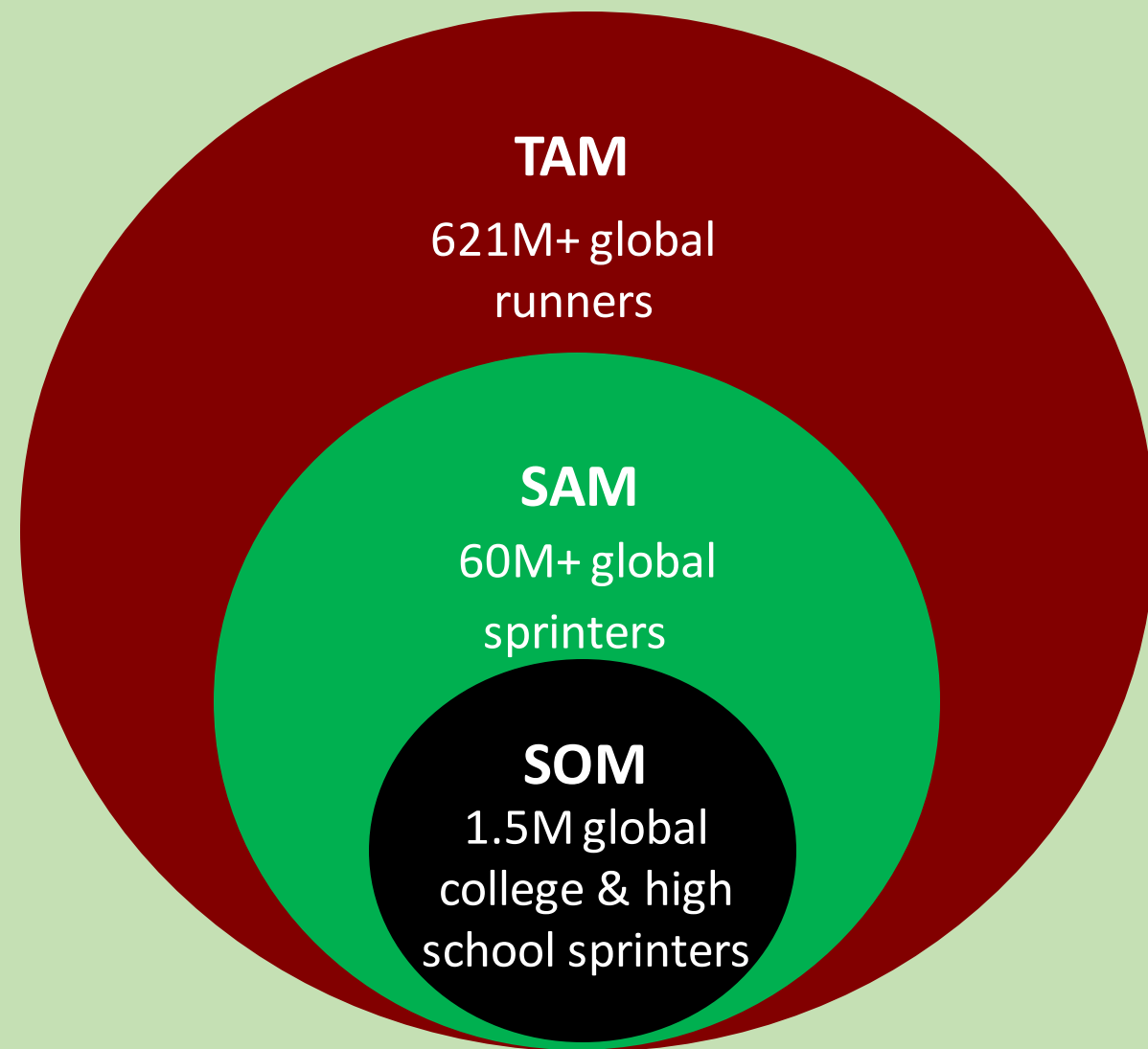

Bill of Materials

- <https://adminmyfsu.sharepoint.com/:x:/s/sdteamsocs/EU1Vb6HjAeBLr7aN8wClnOMBhQLjuxdepSILf4nsBQr-QA?e=007dWU>

