



Presentation 2- Emergency Management Drone Team 307



FAMU-FSU
COLLEGE OF
ENGINEERING

FSU 
**EMERGENCY
MANAGEMENT**
& HOMELAND SECURITY PROGRAM

Team Introduction



Haley Barrett
Project Manager



Matthew Roberts
ECE Lead

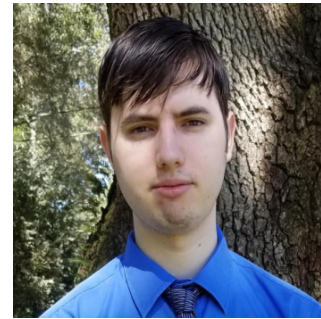

Kody Koch
ME Lead



Josh Reid
Lead Designer/Aerodynamic Engi.



Juan Patino
Test Engineer



Francisco Silva
Lead Programmer/Web Dev.



Sponsor



**Florida State University
Emergency Management and Homeland Security Program**

- **David Merrick, Director**





Introduction: Project and Requirements



FAMU-FSU
COLLEGE OF
ENGINEERING

FSU 
**EMERGENCY
MANAGEMENT
& HOMELAND SECURITY PROGRAM**

The Project



Emergency Management Drone

- Purpose
 - To design a drone capable of assisting search and rescue teams in finding targets
 - Should help search in hard to navigate areas, and in large, dense environments



FSU
EMERGENCY
MANAGEMENT
& HOMELAND SECURITY PROGRAM



FAMU-FSU
COLLEGE OF
ENGINEERING

Requirements



List of design requirements defined from customer needs

- Increase range significantly
- Flight time of at least 20 minutes
- Reduce image blurriness
- Additional user interface options
- Automatic pathfinding
- New weight limitation of 2 kg



FAMU-FSU
COLLEGE OF
ENGINEERING

Targets



FAMU-FSU
COLLEGE OF
ENGINEERING

FSU 

**EMERGENCY
MANAGEMENT
& HOMELAND SECURITY PROGRAM**

Targets



1. Range (5)
 - a. How far can the drone be operated from the base
 - b. Increased range is essential for new design
 - c. Marginal range 8 km. Ideal range 10 km
2. Flight time (5)
 - a. Amount of time that the drone can remain airborne
 - b. Vital function for the drone practicality
 - c. Marginal value 60 minutes. Ideal value 70 minutes
3. Camera stabilization (4)
 - a. Way of holding the camera used to reduce or compensate the vibrations coming from the drone
 - b. An stable camera will make the image processing much more stable
 - c. Marginal value 50 Hz. Ideal value 30 Hz



Targets Cont.



FAMU-FSU
COLLEGE OF
ENGINEERING

4. Cruise Speed (1)
 - a. How fast can the drone be operated from the base
 - b. Increased range is essential for new design
 - c. Marginal speed of 20 m/s. Ideal speed of 25 m/s
5. Power Consumption (5)
 - a. Amount of time that the drone can remain airborne
 - b. Vital function for the drone practicality
 - c. Marginal value 150 W. Ideal value 125 W. (Full throttle)
6. Levels of autonomy (4)
 - a. How long the drone can operate without user input
 - b. Having the drone fly autonomously is important for when it will be flying outside user line of sight
 - c. Marginal value 65%. Ideal value 80%.

Targets Cont.



7. Drone Weight (5)
 - a. The total weight of the drone
 - b. Due to new laws coming into effect in the near future, drones must be under 2 kg to be flown outside the operators line of sight.
 - c. Marginal value 2.3 kg. Ideal value 2 kg
8. Payload Weight (5)
 - a. The weight of the nonessential components of the drone.
 - b. Minimizing the weight of the payload will help reduce the weight of the total drone.
 - c. Marginal value 1.5 kg. Ideal value 1 kg.



Concept Generation



FAMU-FSU
COLLEGE OF
ENGINEERING

FSU 
**EMERGENCY
MANAGEMENT
& HOMELAND SECURITY PROGRAM**

Concept Generation



Mechanical Components	Options						
	Multi-Rotor	Fixed Wing					
Vehicle Type	Multi-Rotor	Fixed Wing					
# of Motors	1	2	3	4	5	6	8
Motor Configuration	Quad Rotor “+” Configuration	Quad Rotor “X” Configuration	Y-6 Rotor	X-8 Rotor	Single Nose Motor	Duel Wing Motor	Single Nose & Duel Wing
Frame Material	Carbon Fiber	Foam	PLA Filament	Epoxy Fiberglass	Aluminum	PVC	
Airfoil	NACA 0012	NACA 1408	20-32C Airfoil	NACA 62(2)-615			
Fuselage	Blunt Body	Bluff Body	Narrow Body	Flying Wing			
Landing	Parachute	Belly Land - No Gear	Landing Gear				

FSU
EMERGENCY
MANAGEMENT
& HOMELAND SECURITY PROGRAM



FAMU-FSU
COLLEGE OF
ENGINEERING

Concept Generation Cont.



Motor configurations for multi-rotors

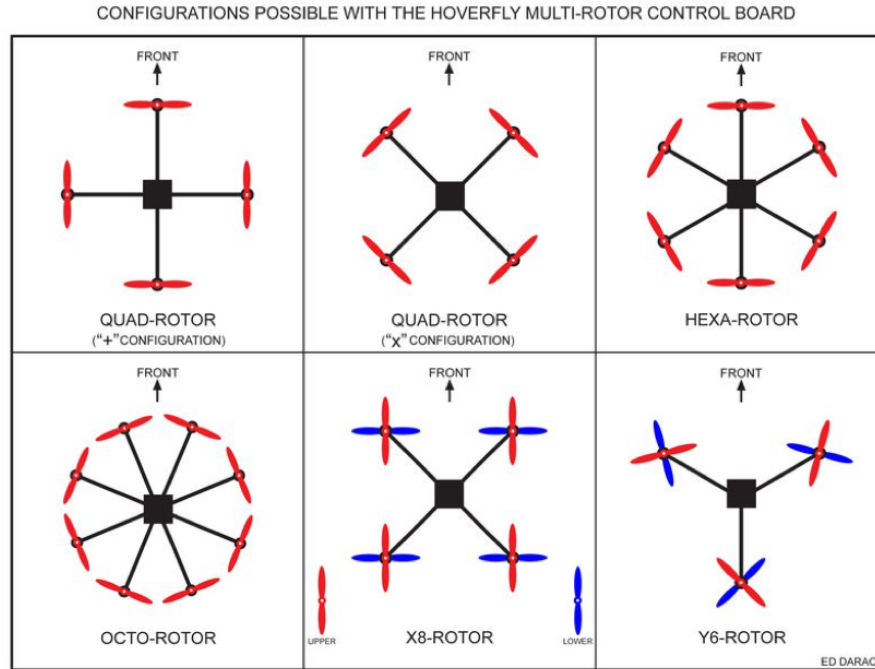

Various motor configurations for multi-rotor drones [1]

Concept Generation Cont.



Airfoil Shapes

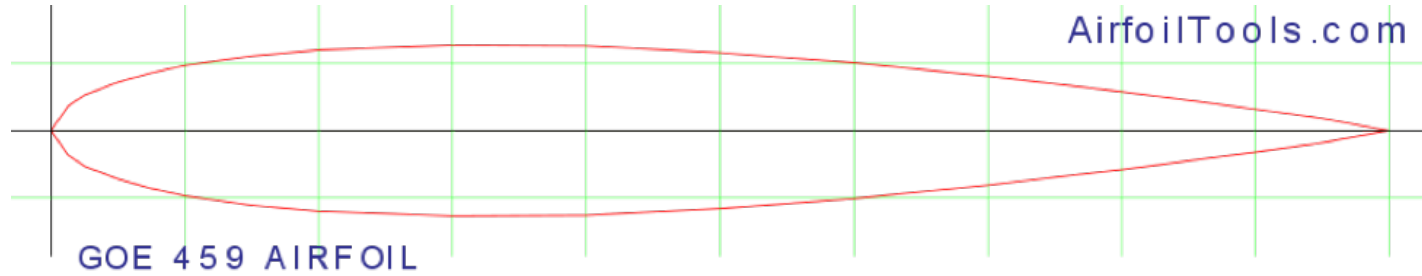

NACA 0012 Airfoil [2]- Mathematically equivalent to paper airplane wing

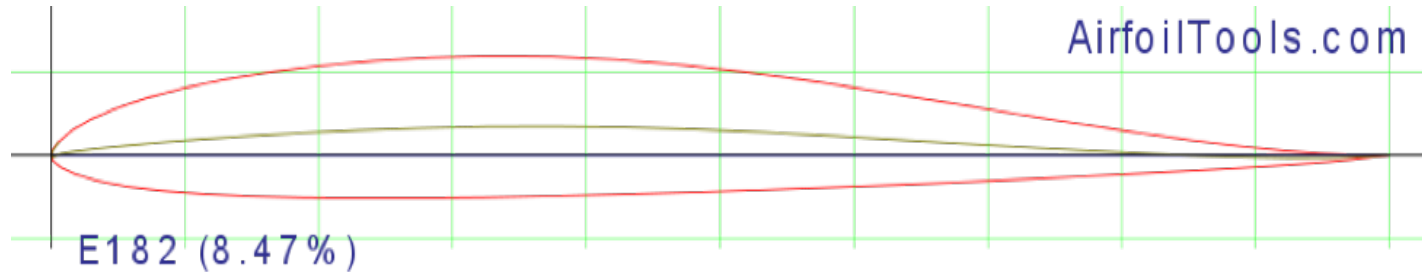

NACA 1408 Airfoil [2]- Generates more lift than a similarly sized thin airfoil

FSU
EMERGENCY
MANAGEMENT
& HOMELAND SECURITY PROGRAM



FAMU-FSU
COLLEGE OF
ENGINEERING

Concept Generation Cont.



Airfoil Shapes

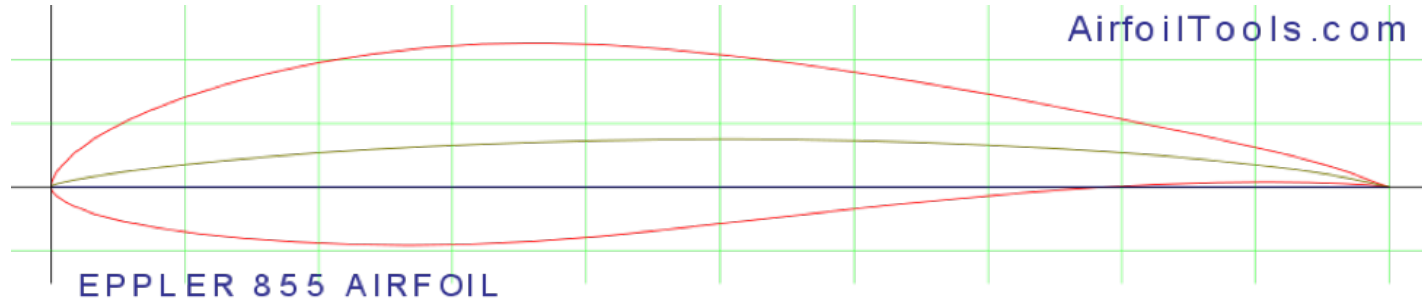

NACA 63(2)-615 Airfoil [2]- Supercritical airfoil which limits transonic effects, like on Boeing 747s

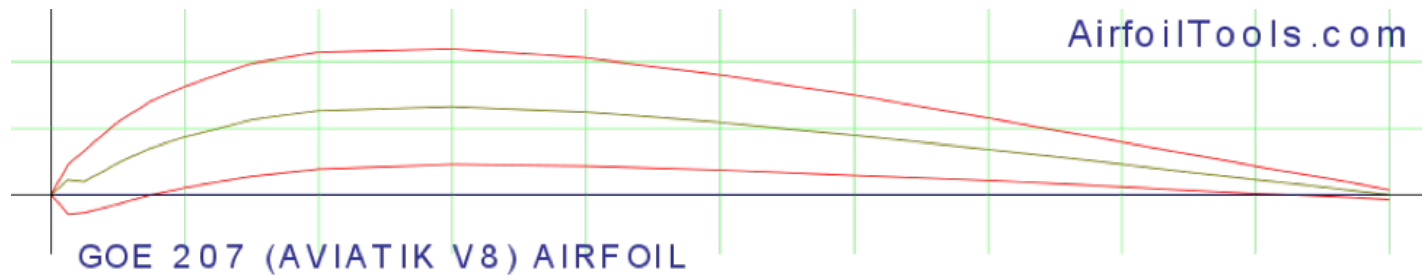

20-32C Airfoil [2]- Mimics avian wings for low speed high lift applications



FAMU-FSU
COLLEGE OF
ENGINEERING

Concept Generation Cont.



Electrical Components	Options					
	Single 3-Cell	Single 4-Cell	Single 6-Cell	Multiple 3-Cell	Multiple 4-Cell	Multiple 6-Cell
Battery	Single 3-Cell	Single 4-Cell	Single 6-Cell	Multiple 3-Cell	Multiple 4-Cell	Multiple 6-Cell
Power Management	Self-Made Power Converter	Multiple OTS Switching Mode Converters	Design around Power Controller - 1 Converter	Design around Power Controller - Multiple Converters		
Communication System	802.11 - WiFi	802.15.4 - Low Rate WPAN	LTE-Advanced - Cellular Connection			
Image Processor	NVIDIA TX1	Raspberry Pi 3B+	Raspberry Pi 2	Raspberry Pi 3B		
Capture Device	Thermal Camera	Infrared Camera	Webcam	Go-Pro	FPV	

Concept Generation Cont.



Concept Definitions

- Number of cells
 - 4 and 6 cells: Higher voltage, less space taken
 - 3 cell: Less voltage, easily accessible, cheaper
- Single or multiple batteries
 - Single: Less weight, shorter flight time
 - Multiple: More weight, longer flight time
- Power controller
 - Buying a module that acts as control system for power converter
 - Complexity: Less than self-made, more than buying converters
 - Can allow for best efficiency for little effort

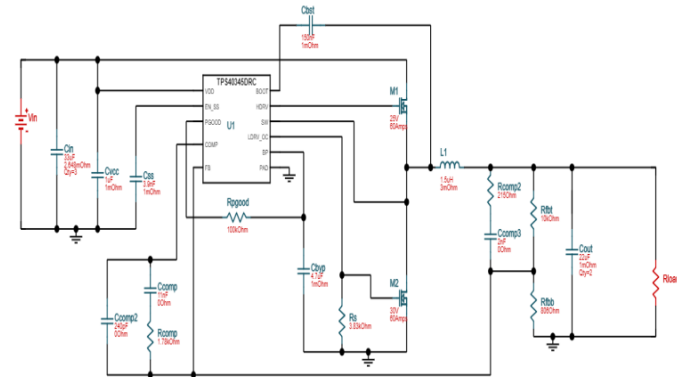

Example of Power Converter Design using a Power Controller and other components [3]

Concept Generation Cont.



FAMU-FSU
COLLEGE OF
ENGINEERING

Concept Definitions Cont.

- Short-range or Satellite
 - Short Range: Low latency, limited range, not based on cellular
 - 4G LTE: High lag, almost unlimited range, based on cellular reception
- WiFi or WPAN (Wireless Personal Area Network)
 - WPAN: Longer range, lower data rate
 - WiFi: Shorter range, faster data rate
- Image processing
 - NVIDIA TX1: More powerful, very power-hungry
 - Raspberry Pi Series: Less powerful, less power-hungry
- Raspberry Pi 2 or 3B or 3B+?
 - Pi 2: Less powerful, smallest output power, smaller, less memory
 - Pi 3B: More powerful, largest output power
 - Pi 3B+: Most powerful, most memory

Concept Generation Cont.



Concept Definitions Cont.

- Camera or Thermal
 - Thermal: Highly accurate at small temperature ranges, expensive, heavier
 - Camera: Accuracy dependent on resolution, requires more in-depth image processing, cheaper, lighter
- Go-Pro, Webcam, or FPV (First-Person-View)
 - Go-Pro: Expensive, best quality, good form factor
 - Webcam: Cheapest, good quality, average form factor
 - FPV: Smallest, worst quality, cheap

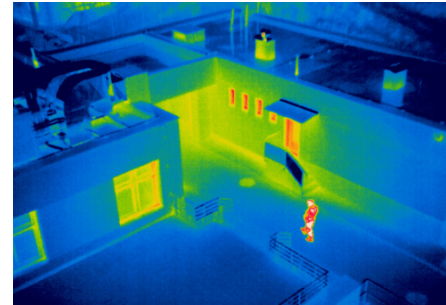

Thermal Camera Example [5]



FPV Camera Example [6]



Webcam Camera Example [7]

FSU
EMERGENCY
MANAGEMENT
& HOMELAND SECURITY PROGRAM



FAMU-FSU
COLLEGE OF
ENGINEERING

Concept Generation Cont.



Exclusions

- Raspberry Pi 1
 - Slow processing speed
 - Not much of a price difference to Raspberry Pi 3B and 3B+
- NVIDIA TK1
 - Lack of power relative to the TX1
- Linear voltage converter
 - Does not provide necessary efficiency to increase flight time
 - Power efficiency is around 30-40% where most power converters lie between 85-95% efficiency
- Narrow body and Blunt body
 - Does not provide enough image stability



FAMU-FSU
COLLEGE OF
ENGINEERING



Concept Selection



FAMU-FSU
COLLEGE OF
ENGINEERING

FSU 
**EMERGENCY
MANAGEMENT
& HOMELAND SECURITY PROGRAM**

Concept Selection



		House of Quality							
		Engineering Requirements							
Customer Requirements	Customer Importance	Power Consumption	Payload Capacity	Camera Stabilization	Image Processing	Weight	Communication	Aerodynamics	
Range	5	3	3	0	3	3	9	3	
Flight Time	5	9	9	0	3	9	3	9	
Cruise Speed	1	3	9	3	0	9	0	9	
Weight	5	9	9	6	3	9	6	6	
Image Quality	4	3	0	9	9	0	9	0	
Autonomous flight	4	3	3	6	0	3	6	3	
Latency	1	0	0	0	6	0	9	0	
									Total
Score		132	126	93	87	126	159	180	903
Relative Weight		14.6	14.0	10.3	9.6	14.0	17.6	19.9	
Rank		3	5	6	7	4	2	1	

Concept Selection Cont.



Metric	Rank	Type	Optimal	Range	Description
Aerodynamics	1	Quality	Optimize	≥ 1.0 at 10° ≤ 0.08 at 5° $\geq 5^\circ$	Minimum Lift Maximum Drag Stall Angle
Communications	2	Value	High	$\geq 2\text{km}$	Communication Range
Power Consumption	3	Value	Low	$\leq 100\text{W}$	Max power consumed from the drone
Weight	4	Value	Low	$\leq 2\text{kg}$	Max weight
Payload Capacity	5	Value	Low	$\leq 1\text{kg}$	How much weight the drone will be able to carry
Camera Stabilization	6	Value	Low	$\leq 30\text{ Hz}$	Max jitter
Image Processing	7	Value	High	$\geq 1\text{fps}$	Processing frame rate

Concept Selection Cont.



Vehicle Type

- Criteria Used: Range, Power Consumption, Mass and Cruise Speed
- Datum Used: “Saurus” Hexacopter
- Concepts: Quadcopter X Configuration, Quadcopter + Configuration, Flying Wing, Bluff Body

Concept Selected:	Flying Wing
Range	High
Power Consumption	Low
Mass	Low
Cruise Speed	Average



Flying Wing [8]



Concept Selection Cont.



Motor Configuration

- Criteria Used: Aerodynamics, Yaw Control, Cruise Speed, Power Consumption, Ease of Construction, Durability, and Cost
- Datum Used: Nose-Mounted Motor
- Concepts: Wings, Nose and Wings, One Rear, Two Rear

Concept Selected	One Rear Motor
Aerodynamics	Ideal
Yaw Control	None
Cruise Speed	Average
Power Consumption	Average
Ease of Construction	Easy
Durability	High
Cost	Average

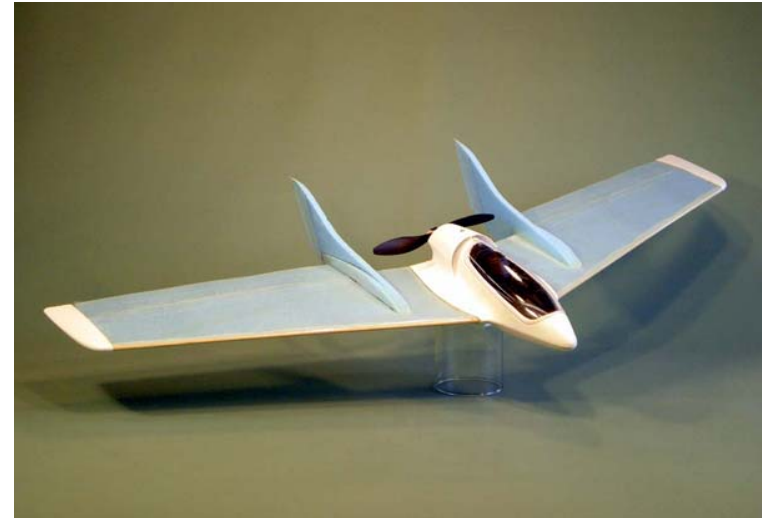

Flying Wing Rear Motor [7]

Concept Selection Cont.



Airfoil Type

- Criteria Used: Lift, Drag, Moment, Stall Characteristics, and Mass
- Datum Used: NACA 0012
- Concepts: NACA 1408, 20-32C Airfoil, NACA 63(2)-615

Concept Selected:	20-32C Airfoil
Lift at 5°	1.15
Drag at 5°	0.04
Moment at 5°	-0.12
Stall Characteristics	Stalls at 6°
Mass	Low

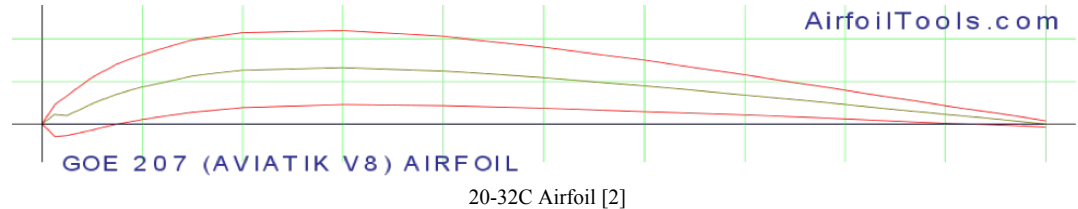

Concept Selection Cont.



Material Type

- Criteria Used: Density, Environmental Strength, Impact Strength, Ease of Construction, Ease of Repair, and Cost
- Datum Used: Carbon Fiber
- Concepts: Foam, Epoxy, PLA Filament, Aluminum, PVC

Concept Selected:	Foam
Density	28.4 kg/m ³
Impact Strength	210 kPa
Environmental Durability	High
Ease of Construction	Easy
Ease of Repair	Easy
Cost	\$20.98 each



Foam Insulation [11]



Concept Selection Cont.



Power Management

- Criteria used: Efficiency, complexity, cost and footprint
- Datum: TI power controller
- Concepts: Design power converter and buy an off-the-shelf converter

Concept Selected:	Use of TI Power Controllers
Efficiency	~97%
Complexity	Somewhat complex
Cost	~\$10
Footprint	439 mm ²

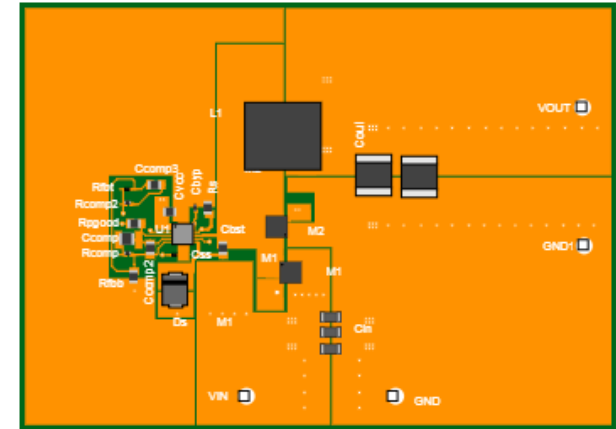

Top converter PCB layout [3]

Concept Selection Cont.



Camera

- Criteria used: Weight, cost, HD recording, Still photo resolution
- Datum: Logitech C920 HD PRO
- Concepts: GoPro Hero 7 Silver, Polaroid cube +, Kodak Pixpro S360

Concept Selected:	Logitech C920 HD PRO
Weight	162g
Cost	\$60
HD recording	720/30fps
Photo resolution	15MP



Logitech C920 HD PRO [12]

Concept Selection Cont.



Main Processing Unit

- Criteria used: Power requirement, Power consumption, size, weight and processing power
- Datum: Raspberry Pi 3 B+
- Concepts: Raspberry Pi 3 B, NVIDIA TX1 and Raspberry Pi 2

Concept Selected:	Raspberry Pi 3 B+
Power requirement	5V and 2A
Max power consumption	12.5W
Size	82mm x 56mm x 19.5mm
Weight	50g
Processing power	1.4GHz and 1GB LPDDR2

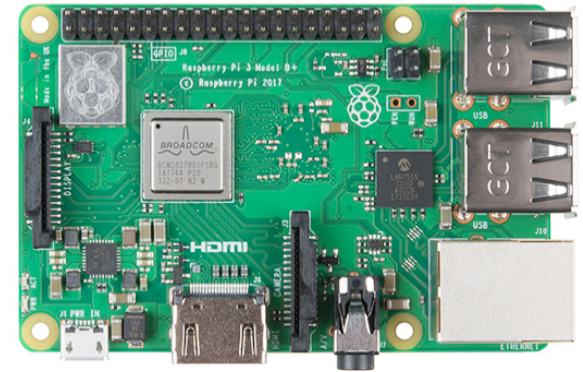

Raspberry Pi 3 B+ [13]

Concept Selection Cont.



Battery

- $P_{\text{RaspPi}} = (5\text{V}) * (2.5\text{A}) = 12.5\text{W}$
- $P_{\text{MOTOR}} = (8.1\text{A}) * (13\text{A}) = 105.30\text{W}$
- Average efficiency of converters = 95%
- Approximate Total power consumption = 124W
- Number of batteries = 2
- 80% of battery capacity = 12800mAh
- Meets target of flight time

$$\text{Flight time} = \frac{(12800) * (11.1)}{(124) * (1000)} = 1.1458 * (60) = 68.75 \cong 69 \text{ minutes}$$

Battery Capacity	8000mAh LiPo
Voltage	11.1V
Discharge rate	50C
Weight	424g
Size	130mm x 40mm x 31mm



Ovonic Battery

Concept Selection Cont.



Telecommunications

- Criteria used: Range, latency, potential data rate and complexity
- Datum: 802.15.4 WPAN
- Concepts: WiFi and LTE

Concept Selected:	802.15.4 - WPAN
Range	Up to 100 km
Latency	Low
Potential Data Rate	Up to 2 Mbps
Power	Up to 1 W

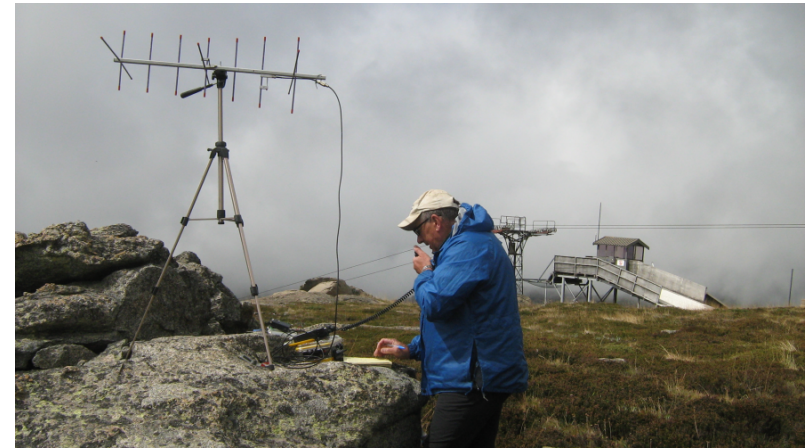

802.15.4 WPAN Example

Concept Selection Cont.



Choosing a transceiver

- TI CC1310 and XBee PRO SX Module: Programmable v.s. configurable
- Receiver sensitivities are based on data rate and bit error
 - A major factor in drone range
- Goal: Maximizing distance while minimizing image errors

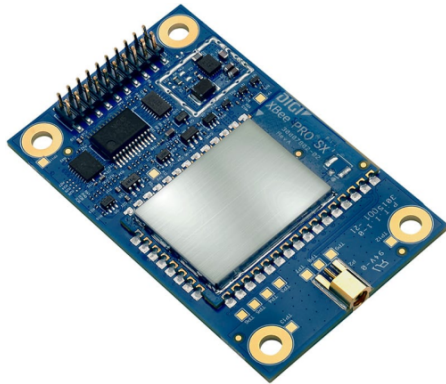

XBee PRO SX



TI CC1310 Launchpad



FAMU-FSU
COLLEGE OF
ENGINEERING

Telecommunications Selection



$$P_r = Q^{-1}(p_e)^2 * \frac{R * N}{B}$$

Receiver Sensitivity Equation

- Rx Bandwidth (B) : 100 kHz (TI), 38.4 kHz (XBee)
- Data Rate (R) : 50 kbps (TI), 38.4 kbps (XBee)
- Noise Power (N) : $3.695 * 10^{-12}$ mW
- p_e = Probability of bit error
- Q^{-1} = Inverse Q function (tail distribution function)
- Chosen Probability of Bit Error: 10^{-5}
- **Resulting Sensitivity: -104.7 dBm**

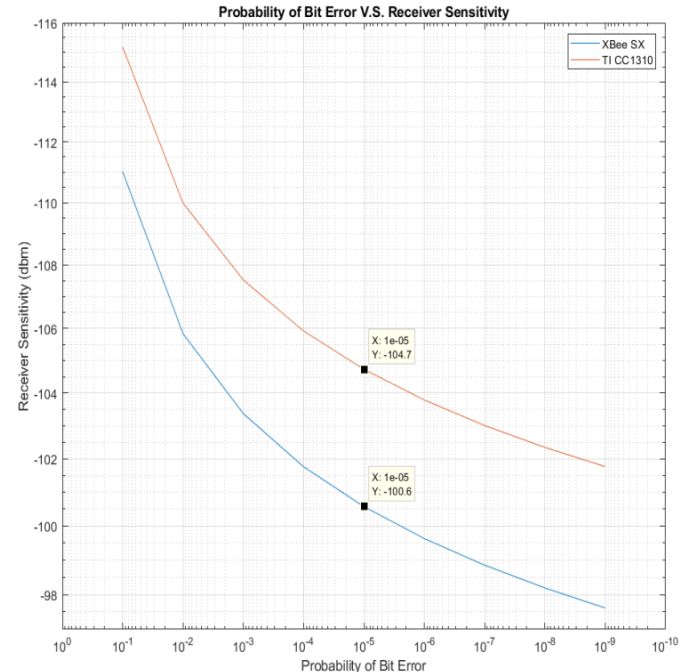

Comparing TI and XBee Sensitivities



Telecommunications Selection



- G_t = Gain of transmitter antenna, 10 dBi, 10 (HG Yagi)
- G_r = Gain of receiver antenna, 3 dBi, 2 (HG Omni)
- P_t = Power transmitted, 15 mW (TI CC1310 Max power)
- P_r = Power received/sensitivity, -104.7 dBm, or $3.39 * 10^{-11}$ mW
- h_t = Height of transmitter antenna, 1 m (Base)
- h_r = Height of receiver antenna, 115 m (Drone)
- L_o = Other losses (fading, multiplathing), 5 dB, or 3.16
- d = Maximum range of communication (at 50 kbps)

$$d = \sqrt[4]{\frac{P_t G_t G_r (h_t h_r)^2}{P_r L_o}}$$

Plane Earth Model

$$d = \sqrt[4]{\frac{(15)*(10)*(2)*(115*1)^2}{(3.39*10^{-11})*(3.16)}} = \boxed{13.872 \text{ km}}$$

Higher than the ideal target value, 10 km!





Bill of Materials And Testing







FAMU-FSU
COLLEGE OF
ENGINEERING

FSU 
**EMERGENCY
MANAGEMENT**
& HOMELAND SECURITY PROGRAM

Bill of Materials

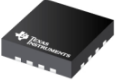



Electrical

	3-Cell Battery	8000mAh Lipo Battery 50C, 11.1V	\$99.99
	Processor Synchronous Buck Controller	TPS53819A Step-Down Controller	\$0.99
	Motor Synchronous Buck Controller	TPS40345 Input Synchronous Buck Controller	\$0.75
	Two Transceiver Modules	Launchpad Development Kit	\$58.00
	High-Gain Yagi Antenna	Base Station Antenna	\$39.00
	Lightweight Omnidirectional Antenna	Omnidirectional Antenna for Drone	\$7.63

Bill of Materials





Electrical

	Main Processor	Raspberry Pi 3 B+	\$35.00
	Camera	720p Logitech Camera	\$0.00
	Flight Control System	Pixhawk 4	\$0.00

Bill of Materials







Electrical

	Motor Controller	ESC 20A	\$12.00
	GPS Module	GPS with Compass Kit	\$0.00

Bill of Materials



Mechanical

	Motor	BL2210/25 Motor	\$13.88
	Propellor	Two 7x5 Propellers (7" Diameter)	\$2.00
	Wings and Fuselage	Three 96"x48"x2" Sheet EPS Foam	\$62.94
	Control Surfaces	Two ES951 5g Digital Servo	\$12.98
	Control Surfaces	Linkage Rod Set	\$4.99

Testing



Next steps

- Telecommunications
 - Test the range and data rate of the communication system and compare the results with the calculated values
 - Reprogram the transceiver taking into account the data from the previous test
 - Interface the Raspberry Pi 3B+ with the communication transceiver
- Image processing
 - Work with the previous team HSV color filtering algorithm
 - Test the image processing performance of the Raspberry Pi 3 B+



Testing image [10]

Testing Cont.



Frame

- Iteratively test the flight characteristics at various levels
 - Hand toss
 - Short flight
 - Etc.

Motors and servos

- Verify the power usage and output of each component
- Verify the thrust of the motor and propellor combination at particular power outputs



FAMU-FSU
COLLEGE OF
ENGINEERING

Conclusion



FAMU-FSU
COLLEGE OF
ENGINEERING

FSU 
**EMERGENCY
MANAGEMENT
& HOMELAND SECURITY PROGRAM**

Conclusion



What to leave with...

- Final design will be a fixed wing drone
- Flight time and range were the two most important factors considered for the final selection of parts
- Previous drone image processing implementation will be analyzed to find ways to optimize it for the new drone design
- Next steps: Testing, Prototyping, Risk assessment and Spring project plan

FSU
EMERGENCY
MANAGEMENT
& HOMELAND SECURITY PROGRAM



FAMU-FSU
COLLEGE OF
ENGINEERING



Flying wing drone [8]

References



1. Darack, E. (2014, May 21). Build Your Own Drone. Retrieved October 21, 2018, from <https://www.airspacemag.com/flight-today/build-your-own-drone-180951417/>
2. Airfoil Tools. (2018). Retrieved November 1, 2018, from <http://airfoiltools.com/H>
3. TI Webench. (2018). Retrieved November 11, 2018, from <https://webench.ti.com/power-designer/switching-regulator/customize/18>
4. Hazbun, C. (2018, March 26). The History of Thermal Imaging Cameras. Retrieved November 12, 2018, from <https://www.ecamsecure.com/blog/thermal-cameras/history-thermal-imaging-cameras/>
5. Flynt, J. (2017, September 08). What is FPV? FPV Definition: First Person View Quadcopter Camera. Retrieved November 12, 2018, from <https://3dinsider.com/what-is-fpv/>
6. (n.d.). Retrieved November 12, 2018, from <http://www.cargolaw.com/cameras.html>
7. Jarel Aircraft Design. (n.d.). Retrieved November 15, 2018, from <http://jarelaircraftdesign.com/products/icon-flying-wing>
8. SenseFly's Latest Fixed-Wing Mapping Drone Is Here. (2016, October 13). Retrieved from <https://unmanned-aerial.com/senseflys-latest-fixed-wing-mapping-drone-is-here>
9. CF 1030mm Delta Wing FPV RC Airplane KIT - \$70.01 Free Shipping. (n.d.). Retrieved November 15, 2018, from https://www.gearbest.com/rc-airplanes/pp_1579286.html?wid=1433363
10. (n.d.). Retrieved November 15, 2018, from <http://techengineers.com/software-testing/>
11. Mario, Paul, & Deb. (2018, November 06). R-Tech 2 in. x 4 ft. x 8 ft. R-7.7 Rigid Foam Insulation-310891. Retrieved November 15, 2018, from <https://www.homedepot.com/p/R-Tech-2-in-x-4-ft-x-8-ft-R-7-7-Rigid-Foam-Insulation-310891/202532856>
12. C920 HD Pro Webcam. (n.d.). Retrieved from <https://www.logitech.com/en-us/product/hd-pro-webcam-c920>
13. Qamar. (n.d.). Raspberry Pi 3 B. Retrieved from <https://www.sparkfun.com/products/14643>



Questions?



FAMU-FSU
COLLEGE OF
ENGINEERING

FSU 
**EMERGENCY
MANAGEMENT
& HOMELAND SECURITY PROGRAM**