

# Operation Manual

*Team 8: AUVSI Design Competition*

SUBMITTED: 4/3/2015

SUBMITTED TO: DR. GUPTA, DR. FRANK, DR. SHIH

AUTHORS: CHRISTOPHER BERGLJUNG, JERMAINE DICKEY,  
WILL DI SCIPIO, DAVID HEGG, GAVARNI LEONCE, JOHN  
MURNANE, AND TAVARIUS SLAUGHTER

## CONTENTS

I	Introduction . . . . .	1
II	Function Analysis . . . . .	1
III	Project/Product Specification . . . . .	2
	III-A Material Selection for Quadrotor and Control System . . . . .	2
IV	Quadrotor Frame Assembly . . . . .	3
	IV-A Base Assembly . . . . .	3
V	Electrical Component Assembly . . . . .	6
	V-A RC Transmitter and Receiver . . . . .	6
	V-B Batteries . . . . .	6
	V-C APM 2.6 and Mission Planner . . . . .	7
VI	Operation Instruction . . . . .	7
	VI-A Pre-flight Instruction . . . . .	7
	VI-B In-flight Instruction . . . . .	8
	VI-C Post-flight Instruction . . . . .	8
VII	Troubleshooting . . . . .	9
	VII-A APM not connecting to Mission Planner . . . . .	9
	VII-B Aircraft not turning on . . . . .	9
	VII-C The aircraft not responding to inputs . . . . .	9
	VII-D The aircraft flying erratically . . . . .	9
	VII-E Wireless signal being lost . . . . .	9
	VII-F Other Difficulties . . . . .	10
VIII	Regular Maintenance/ Service . . . . .	10
IX	Spare Parts . . . . .	10
X	Summary . . . . .	10
	References . . . . .	11

## LIST OF FIGURES

1	Senior Telemaster Plane with Quadrotor Attachment. . . . .	3
2	Base Plate Attachment. . . . .	3
3	Front and Rear Assembly junction of base plate and 6061 Square Aluminum . . . . .	3
4	Placement of foam padding over the base. . . . .	4
5	Clamps secure the carbon fiber rods in a rigid manner. . . . .	4
6	Components and assembly of carbon fiber tubes and motor with mounts . . . . .	5
7	Propeller placed onto motor. . . . .	5
8	Output cable and RC receiver. . . . .	6

## LIST OF TABLES

I	Total parts list and quantities. . . . .	2
II	Motor Data Sheets. . . . .	2
III	ESC Data Sheets. . . . .	2
IV	Battery Data Sheets. . . . .	2

## I. INTRODUCTION

The quad rotor attachment will work by exhibiting characteristics of both multirotor flight and fixed wing flight. The capabilities associated with fixed wing and multirotor flight are different. Fixed wing planes have longer flight endurance but must maintain forward flight to generate lift. A multi-rotor is capable of stationary hovering but it has a limited flight time because it has to power multiple motors to sustain flight. By being able to integrate favorable characteristics of both vehicles into a single unmanned aerial vehicle, it will have distinct advantages over other aerial vehicles.

This report will describe the operation of the quadcopter attachment that can be attached to an existing RC plane. The quadcopter attachment was designed to meet all rules and regulations of the annual Unmanned Vehicle System International (AUVSI) competition. The operation of the components such as the DC motors, APM, and radio controller are explained below to allow the operator to operate the vehicle in a safe manner. Enjoy and fly safely!

## II. FUNCTION ANALYSIS

The function of this project is to create a Vertical Takeoff and Landing (VTOL) aircraft that can compete in the 2016 AUVSI design competition. This will be done by adding a quadrotor attachment to the already existing Senior Telemaster R/C plane. Adding the VTOL function will give the future team a leg up on the competition with an innovative design.

With this in mind, Team 8's project was to design an attachment to an existing R/C plane so it could have VTOL capabilities. To do this, the existing Senior Telemaster plane needed to be retrofitted with a quad rotor attachment that could give the plane vertical takeoff and landing capabilities. With the designed quad rotor attachment, the plane would have the ability to take off and land vertically. The quad rotor attachment will work like a simple quad rotor vehicle that needs to be able to lift an R/C plane. This is done by matching four DC motors with four props to give the quad rotor enough thrust to be able to handle the weight of the plane. The desired thrust to weight ratio is 2:1 to ensure that the quad rotor can lift the plane and still have maneuverability. This thrust minimum is exceeded with the selected props and rotors used for the design.

One of the harder aspects of this project is the stability of the hybrid vehicle. The vehicle will be stabilized by using an onboard APM which has a built-in accelerometer and gyroscope. The APM uses a proportional integral derivative (PID) controller to take the feedback from the accelerometer and gyroscope to stabilize the vehicle. With this APM, the plane will be able to stabilize by altering different parameters of the PID controller to control the stability of the vehicle. When stabilized, the plane will be able to achieve VTOL, which will be the extent of this operation manual.

### III. PROJECT/PRODUCT SPECIFICATION

#### A. Material Selection for Quadrotor and Control System

Part	Quantity
Plane	1
<i>Attachment Body Materials</i>	
Plywood Base	1
Polyurethane Foam Pad	1
Industrial Strength Velcro	4
Aluminum 6061 Cross Bars	2
Carbon Fiber Arms	2
ABS Arm Mount Bottom	4
ABS Arm Mount Top	4
G-10 Motor Mount Bottom	4
G-10 Motor Mount Top	4
<i>Quad Rotor Components</i>	
6V Battery	1
Venom 22.2V Battery	2
Cobra 60A ESC	4
Cobra Multi Rotor Motor	4
APC Propeller 18x5.5"	4
Adrupilot APM 2.6 and GPS	1
3DR Telemetry Kit	1
Futaba R/C Receiver	1
Wiring	1
Hardware	n/a
<b>Total Number of Parts</b>	<b>46</b>

TABLE I: Total parts list and quantities.

<i>Motor Specifications</i>							
Prop	Size	Lipo Cells	Voltage	Amps	Watts	RPM	Thrust
APC	18x5.5	6	22.2V	38.76	860.5	6414	4468

TABLE II: Motor Data Sheets.

<i>ESC Specifications</i>				
Max Count. Current	Max Burst Current	Operating Range	Number of LiPo cells	BEC Output
60 Amps	70 Amps	8 to 25 Volts	2 to 6 cells	None (opto)

TABLE III: ESC Data Sheets.

<i>Battery Specifications</i>					
Charge Rate	Max Volt/Cell	Max Pack Voltage	Min Discharge Volts	Continuous Discharge	Max Burst Rate
5A (1C)	4.2V	25.2V	18V	25C	35C

TABLE IV: Battery Data Sheets.

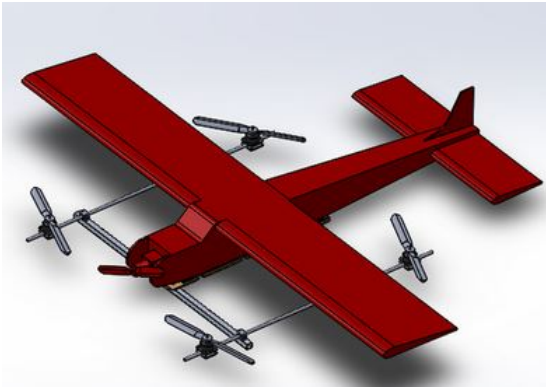

Fig. 1: Placement of Quadrotor Frame Attachment in reference to plane.

#### IV. QUADROTOR FRAME ASSEMBLY

This operation manual will give directions on how to assemble the frame to an existing Senior Telemaster R/C plane, however the directions can be applied to any R/C plane, with dimensions that fit within the constraints of the frame.

##### A. Base Assembly

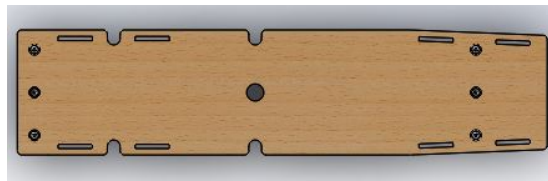

Fig. 2: The frames base plate.

##### 1) Plywood Base joins to 6061 Aluminum Cross Beams:

*a:* Ensure that the two pairs of tri-series holes from base assembly align with the holes drilled in both aluminum rods.

*b:* Once both rods are aligned, ensure that rods are positioned so that the holes on either side (where the motor clamps attach) are face up.

*c:* Use 6 1/4"-20 screws, washers, and lock nuts to secure front and rear rod to the base assembly, Figure 3

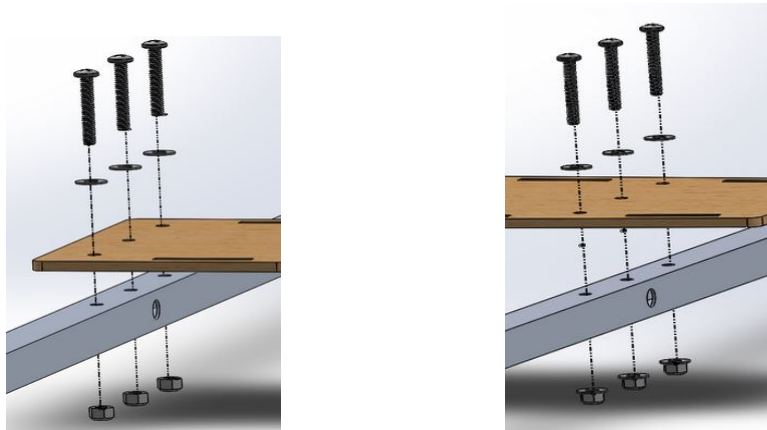

A: Assembled view of clamp and motor mounts    B: Exploded view of clamp and motor mounts

Fig. 3: Aluminum 6061 rods are attached to the front (A) and rear(B) of the base plate.

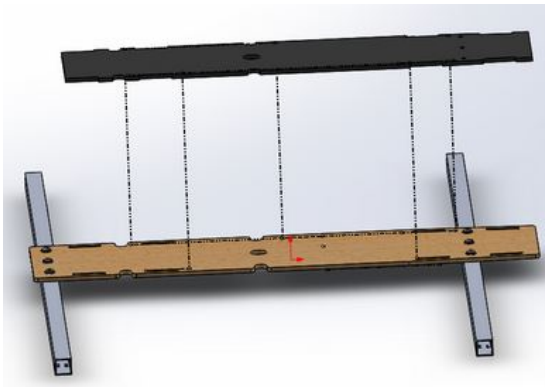

Fig. 4: Foam padding must be properly aligned and placed over the plywood base to minimize the risk of damaging the R/C plane.

2) *Quick-Recovery Polyurethane Foam*: Used to ensure bottom of Telemaster R/C Plane is not damaged by the hard plywood base or screw heads that protrude from the base. Also the foam will dampen vibrations.

*a*: Before exposing adhesive, ensure padding slots align with slots cut into plywood base.

*b*: Once aligned, use pencil to trace the edge to use as a reference to align pad when sticking to plywood, (step d).

*c*: To attach pad onto base, user must first peel plastic layer to expose adhesive.

*d*: Align the padding to reference line similar to what you did in step b.

*e*: When aligned, slowly roll pad across plywood surface to ensure that no air bubbles are trapped between the two layers.

*f*: Allow adhesive to stick for five minutes before continuing.

3) *Carbon Fiber Tubes with Clamps*:

*a*: At this point the assembly of the ply wood base and aluminum 6061 should be complete.

*b*: The clamps comes in two pieces; a bottom and top piece, which clamp around the carbon fiber rod and attach to the square aluminum rod. A pin has been supplied to ensure alignment of carbon fiber rod.

*c*: Place carbon fiber rod, Figure 5, into the bottom clamp piece so that the carbon fiber tubes is supported on both sides by the clamps, Figure 5. Ensure that the pin in the top clamp aligns with the hole drilled into the carbon fiber tube.

*d*: Motor mounts should be oriented so that they are under the carbon tubes.

*e*: Place the top clamp piece over the the carbon fiber rod and slide the screws into the outer holes.

*f*: Repeat steps until all clamps are on and then use 10-24x2 1/4" screws, washers, and lock nuts to secure the clamps.

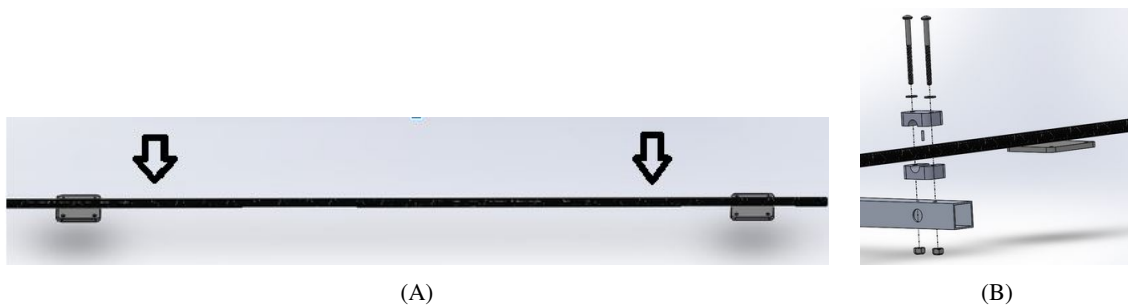

Fig. 5: Carbon fiber tubes, (A), are placed between the top and bottom pieces of the clamp assembly, (B). A pin on the clamp's top piece will hold it in a vertical orientation.

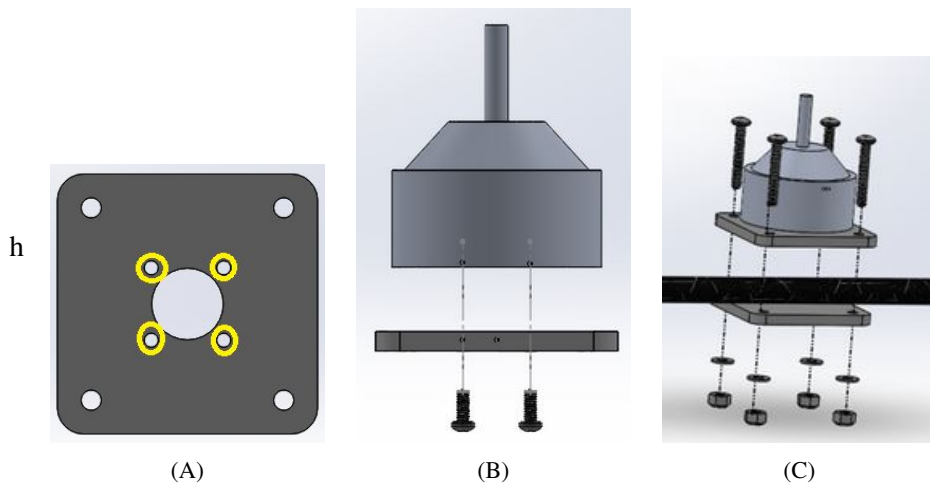

Fig. 6: The base plate has four holes, (A), for screws that will attach the motor to its base, (B). Once they are attached the motor base can then be attached with screws to the mounts on the carbon fiber tube, (C).

5) *Motor Mount to Carbon Fiber Rod:*

a: Align the four small holes, in Figure 6, on the bottom of the motor with the inner holes on the motor mounts.

b: Use four M3 screws to secure the motor and mount together securely, Figure 6. Be careful not to overtighten screws.

c: Once motor is attached, align four outer holes on the motor mount with the four outer holes on the G-10 motor base which is attached to the carbon fiber rods, Figure 6.

d: Use the 10-24x1.5" screws, washers, and lock nuts to tighten the four corners evenly to maintain proper orientation.

6) *Industrial Strength Velcro:* Joins the Telemaster R/C plane to the quadrotor attachment.

a: With steps 1-5 completed, take the plane and place it on top of the frame base.

b: With plane in position, feed the Velcro straps through the holes on the base and fold the Velcro over the plane.

c: Fold other half over the strip and tighten.

d: Repeat a-c until all straps are secure.

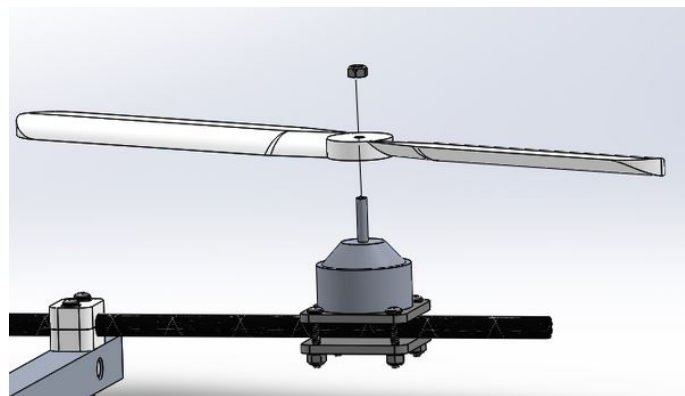

Fig. 7: The propeller is placed on the protrusion on top of the motor and then secured to the motor with the motor's provided screws.

7) *APC 18x5 CW/CCW props:*

a: The front right propeller should be counterclockwise, and the back right propeller should be clockwise.

b: The back left propeller should be counterclockwise, and the front left propeller should be clockwise

c: The propellers should be attached to the motors using the nut and washers provided with the motors. See Figure 7.

## V. ELECTRICAL COMPONENT ASSEMBLY

### A. RC Transmitter and Receiver

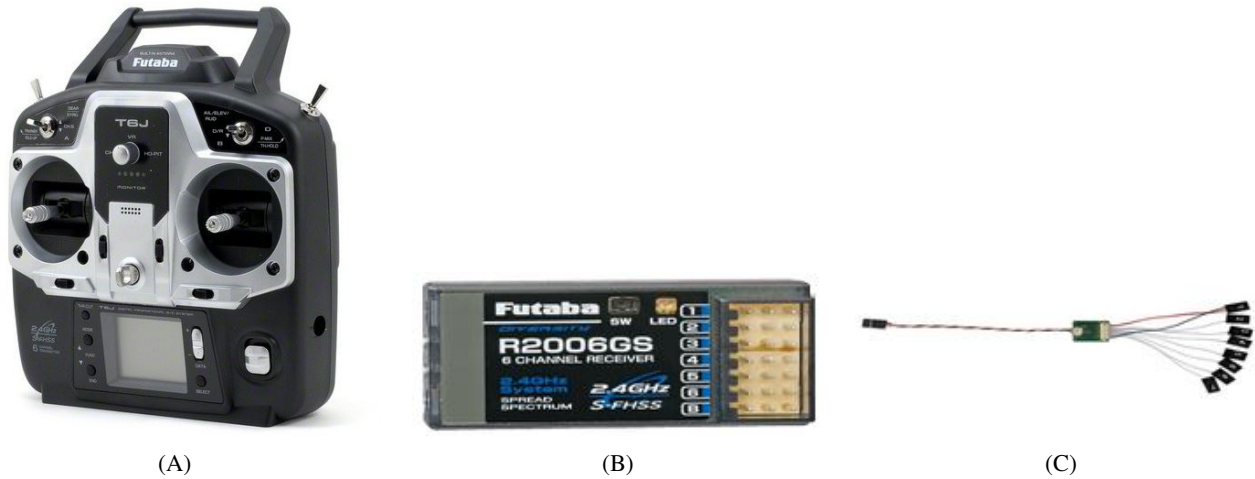

Fig. 8: Futaba T6J 6-Channel Transmitter, (A), communicates with Futaba R2006GS 6 channel receiver (B). Output cables, (C), are placed into receiver to connect to APM port.

The hybrid multirotor airplane system utilizes the Futaba T6J 6-channel transmitter and the Futaba R2006GS 6 channel receiver for manual flight. It is important that every pilot to understand how to operate the transmitter before flying the aircraft. Please visit the following link for detailed explanation on how to utilize the transmitter. [2]

### B. Batteries

It is necessary for the user to prepare the batteries before connecting them to the system. Primarily, the system utilizes three Venom 25C 5Ah 22.2V LiPo batteries to power the aircraft. Two of which are connected in parallel for powering the quad-rotor motors and the last one is to power the front motor of the plane for forward flight. Additionally, a NiMH battery is use to power the APM 2.6 board and all of its inputs. All batteries should be fully charged before powering the system. The V6AC Balance Charger can be used for both LiPo and NiMH batteries.

#### 1) Charging LiPo and NiMH Batteries:

*a:* Connect the AC power supply to any wall socket and the other end of the power supply to the charger. Note: The charger can be power by a DC power supply with an input voltage of 11 V and 18V, and a draw current between .1A to .5A.

*b:* Connect the positive and negative male leads into their corresponding port on the charger, then connect the male connectors to the female connectors of the battery. Note: When charging a LiPo battery, you should connect the battery balance connector into the balance socket on the charger.

*c:* Use the stop button to select the type of battery that you want to charge.

*d:* Press the start button to adjust charging parameters.

*e:* Utilize the status buttons on the charger to select a charge current that is between .1C and .4C. Note: For a battery with a capacity of 5Ah the maximum charge current would be equal to 2A and the minimum charge current would be .5A.

*f:* Hit the start button again to adjust the battery voltage

*g:* Hold down the start button to start the charging process.

*h:* Press start again to confirm the information that appears on the LCD screen.

*i:* Remove all connections from charger when the charger indicates that the battery is fully charged.

*j:* For trouble with the charger please follow the link, [3]

*k:* Remember to follow all manufactures safety procedures during the charging of LiPo batteries.



### C. APM 2.6 and Mission Planner

It is mandatory for the user to download the Mission Planner software onto his or her operating system. The instructions for downloading Mission Planner can be found from their website, [4]. Once mission planner is installed, the user should proceed with setting up the APM by observing these procedures.

#### 1) APM:

- a: Connect the four pin cable (compass) and five pin cable (GPS) into their respective port on the 3DR uBlox GPS with compass kit.
- b: Plug the compass cable into the I2C port and the GPS cable in the top GPS port.
- c: Connect the ppm jumper into signal pin 2 and pin 3.
- d: Plug ppm sum receiver into input port 1 and the output cables into their corresponding port on the Futaba R2006GS 6 channel receiver.
- e: Connect the micro end of the micro-usb cable into the micro port of the APM and the usb end into a computer with Mission Planner installed.
- f: Launch Mission Planner.
- g: Click on the initial setup tab and install VTOL firmware.
- h: Open the mandatory hardware tab and perform all required hardware calibration.
- i: Disconnect the micro-usb cable from the APM and the computer.
- j: Connect the ppm jumper into input signal pin 2 and pin 3.
- k: Connect the 3DR telemetry receiver into the telemetry port.
- l: Connect the APM power module in the PM port.
- m: Connect the 4 DC motor signal wires into their corresponding output ports.
- n: Connect the planes front motor signal wire into output port 5.
- o: Connect the aileron signal wire into port 6.
- p: Connect the elevator signal wire into port 7.
- q: Connect the rudder signal wire into port 8.
- r: Connect the 6V NiMH battery into the APM power module.
- s: Connect the EC5 connectors from the plane into the EC5 connectors from the 22.2V LiPo battery inside of the plane.
- t: Connect each of the EC5 connectors from the batteries underneath the plane into a EC5 connector from the wiring harness.

## VI. OPERATION INSTRUCTION

The operation of the aircraft must be broken into pre-flight instruction, in-flight instruction, and post-flight instruction. Each of these is highly important in ensuring safe operation of the aircraft. When operating the aircraft or dealing with any problems proper safety precautions must be taken. These include never approaching the aircraft while it is operating, unplugging the batteries before working on the aircraft, and always operating in a clear area free from obstructions or other people. When testing the aircraft the plane must be properly tethered to avoid it crashing into people or objects. Furthermore, the aircraft should never be flown above peoples heads.

### A. Pre-flight Instruction

While preparing the aircraft before flight a structural inspection must be done in order to ensure that the aircraft is airworthy. This involves, first, doing a visually and manually inspecting all components of the vehicle. The plane and quadcopter frame must be free of defects such as holes and cracks. To ensure a good connection between the quadcopter frame and the plane, the frame should be lightly jostled by hand. If anything falls off or is loose then closer inspection will be necessary. The four motors on the quadcopter frame should be spun by hand to make sure they rotate freely and do not collide with any part of the aircraft. The front motor should be spun by hand too. The wiring from the motors, servos, and other peripherals must be followed from their ends all the way back to where they plug into the APM. If there are any disconnections or damages to the wiring then they must be inspected and fixed.

Next, it will be necessary to attach the batteries to the underside of the aircraft as well as the 3DR and any other external accessories. It is at this point that the aircraft will have all the necessary components to fly and be fully

assembled. Thus, the center of gravity will need to be checked. This will ensure that the aircraft will be optimally balanced for vertical flight and will fly level in horizontal flight. To execute this, the aircraft should be lifted up at the bottom at a point under the wings and centered on the body. If the plane leans towards any direction and does not balance then the hand holding the plane should be moved to a point either closer to the front of the plane or the back. The idea is to find the point where the plane does not fall backwards, right, left, or extremely forward. If the plane tilts a little bit forward than this is acceptable. The ideal center of gravity should be under the wings of the plane. To get to this point then the batteries underneath the plane can be moved to where they correlate the desired center of gravity.

The next step is to make sure that the control surfaces of the aircraft are functional. These include the ailerons, elevator, rudder, and flaps. The transmitter can be used to activate the servos which control these surfaces. Each surface should be tested individually. If a control surface does not respond properly then the servo connected to it should be inspected. Once all the control surfaces have been tested and respond properly then the throw values must be set. The throw values are set to control the amount of deflection each of the control surfaces undergo during their maximum extension. For this aircraft the throw values should be set for the ailerons, elevator, and rudder. The ailerons have values of 25mm up and 20mm down. The elevator has values of 20mm up and 20mm down. The rudder has values of 35mm left and 35mm right. For further instructions consult the manual for the plane[2].

After this then both the plane and the quadcopter must be activated. This is done through Mission Planner. In Mission Planner the aircrafts APM must be selected and linked to. This can be done either through the MAV link or wirelessly through the 3DR telemetry kit. After this the proper firmware must be selected. For the current purposes the quadcopter firmware should be installed on the aircraft. Once this is done then there should be some indication from the aircraft and Mission Planner. At this point the onboard sensors need to be calibrated. This includes the magnetometer, gyroscope, gps, and barometer. In Mission Planner, the orientation of the plane can be monitored as a user tilts the plane forwards, backwards, left, and right. This will ensure the gyroscope and accelerometer. The calibrations involves lifting the plane and moving it around so physical strength and dexterity is required. After making sure the aircraft is in a clear location and free from any obstacles then it is ready to be armed. The plane is armed wirelessly with the Mission Planner software. At this point the aircraft is ready for vertical takeoff.

### *B. In-flight Instruction*

While taking off the aircraft can be flown in either manual or autonomous mode. Until autonomous mode is proven then the desired takeoff will be manually. Before takeoff, the aircraft must be propped up from the back so that the quadcopter frame is level at a horizontal. This ensures that when the throttle is applied the thrust will be directed vertically. To manually take off, the thrust joystick on the transmitter should be slowly pushed up. The farther up the joystick, the more thrust will be generated. The plane should be throttled to give it enough thrust to ascend at the desired velocity. The plane should only spend a minimal amount of time in the region below about 3 feet. This is in order to minimize the effects of downwash which can be highly detrimental to the aircraft. Once free from this range the throttle should be carefully applied until the aircraft reached the desired operated height.

While hovering the effects of the aircrafts asymmetry and of the environment will cause the flight to be unsteady. The aircraft will attempt to compensate for these forces with the PID controller in the APM. The plane can also be steadied and maneuvered using the joystick that controls the pitch and roll. Ideally, the aircraft will be turned to face the wind (if any). This will allow for the airflow to travel over the aircrafts wings which will then generate lift. In doing so, the aircraft will be more stable and will have the best conditions to transition to horizontal flight.

When landing, care should be taken as to the landing zone. The landing zone must have minimal grade, be free of obstacles, and be of adequate space. To land the throttle must be decreased slowly. The rate should be such that the aircraft does not descend rapidly. After traveling down to a height of about 2.5 feet then the throttle can be dropped more rapidly so to minimize the ground effect. Once it makes touchdown with the ground, the throttle can be cut. At this point the plane should not be approached by any means as it is still armed. The plane should then be disarmed and then it can be approached for post flight operations.

### *C. Post-flight Instruction*

After the aircraft is disarmed then the first step is to disconnect the batteries to eliminate any chance of the propellers turning on. The propellers are large and spin at a high speed so they can be extremely hazardous and

cause bodily injury. Proper care must be taken at all times to never be within the range of the blades while the power is connected and the system armed. After the power is disconnected then the propellers may be removed from the four quadcopter motors. Then the rest of the electrical components such as the APM and 3DR telemetry kit should be unplugged and removed for safe transport. The wings of the aircraft should be removed and, if transporting in a car, the quadcopter frame should be detached from the plane. When everything is detached each of the components (wings, quadcopter frame, electronics, and plane frame) should be treated carefully and stowed safely so as to minimize damage to the fragile parts. The batteries should be charged as soon as possible so that they are not stored empty. This is detrimental to the LiPo batteries.

## VII. TROUBLESHOOTING

There are various problems that may arise with this project. These include but are not limited to:

### A. *APM not connecting to Mission Planner*

- 1) : Ensure that the USB cable is properly attached to the APM and the computer running Mission Planner.
- 2) : Ensure that the proper port and baud rate on Mission Planner are selected.
- 3) : If the above does not work, try to unplug and plug USB cable back in to reset the connection.
- 4) : Try a different usb cable.
- 5) : Try a different computer.

### B. *Aircraft not turning on*

- 1) : Check that the batteries are charged using the charger.
- 2) : Ensure that the proper port and baud rate on Mission Planner are selected.
- 3) : If the above does not work, try to unplug and plug USB cable back in to reset the connection..
- 4) : Try a different usb cable.
- 5) : Try a different computer.

### C. *The aircraft not responding to inputs*

- 1) : Check that the plane is on.
- 2) : Make sure that the transmitter is on and working.
- 3) : Check to see that the firmware was properly installed onto the APM from Mission Planner.
- 4) : Check to see that the wiring is intact and properly connected.
- 5) : Try pulling sensor data from Mission Planner through wireless telemetry.
- 6) : Reset APM and Mission Planner.
- 7) : Refer to APM manual.

### D. *The aircraft flying erratically*

- 1) : Land immediately.
- 2) : If aircraft was in vertical mode, check motors and components related to the quadcopter frame.
- 3) : If aircraft was in horizontal mode, check control surfaces and components related to the airplane flight.
- 4) : If problem is in vertical mode and the motors and components of the quadcopter frame appear to be in working order, then recalibrate PID control values.
- 5) : Refer to either the plane manual or the APM manual for further information.

### E. *Wireless signal being lost*

- 1) : Check to see that 3DR telemetry is properly connected to computer usb port.
- 2) : The aircraft should automatically land itself if the signal is lost so proceed to the last known aircraft location immediately.
- 3) : In the future, attempt to minimize obstructions between the computer, transmitter, and the aircraft.

### *F. Other Difficulties*

For all other problems, refer to the Telemaster plane manual, the Futaba transmitter manual, the APM manual, the 3DR telemetry kit manual, the Mission Planner help guides online, and various forums relating to the problem at hand. There is a wealth of information on the internet and it must be utilized to solve problems. Chances are that the problem at hand has been experienced by someone else or someone else has faced a problem related to the one at hand.

## VIII. REGULAR MAINTENANCE/ SERVICE

This hybrid design combines many moving and electrical components that should all be checked before operation to avoid injury and damage on the plane. The plane should be checked before and after every flight as detailed in the operation instructions section. Other than preflight and postflight checks the pieces that should be checked regularly should be the motors, batteries, and the velcro attachments. The DC motors have a long lifetime as long as they are maintained properly, so it is recommended to oil the bearing on the motors every year at least once and keep them away from wet and dirty situations. Batteries will eventually need to be replaced. There are proper ways to charge, use and store batteries and these easily be found online.[8]. The search shows the user the proper way to use the battery and will allow the user to use the battery to its fullest capabilities until it needs to be replaced. The velcro straps should be replaced every year depending on the use of the product. Velcro tends to deteriorate after continued use, so it is recommended that the straps be replaced at least every year at minimum. If excess deteriorated is noticed before a year, the straps should be replaced. It is important for the user to perform the preflight and postflight test every time the product is used. This will allow the user to catch potential problems early so to avoid major problems in the future.

## IX. SPARE PARTS

Safe operation is key to avoiding the need for spare parts, however there are a few parts that are recommended as spare parts because there is higher risks of these being damaged and having a need for replacement. One spare parts to keep on hand are the propellers. The propellers, there is always risk of propellor damage when flying, so to limit down time, at least one extra counter clockwise and one extra clockwise propellor is recommended to be kept by the user. Batteries have limited life time, so having spare batteries is a necessity. Keeping spare batteries will make flight easier for the user as charging individual battery can be tedious. Another spare part to keep is extra Velcro straps. These can be purchased on a yearly as they are recommended to be replaced every year. The Velcro can also be damaged by improper use, so having spare strap will be essential. Lastly, spare signal wire will be needed. Many times loss of connection is due to faulty signal wire and so having a spare set of signal wires is also recommended.

## X. SUMMARY

In summary, this report lays out the operation of all components of the VTOL vehicle. Care must be taken when flying this vehicle because it can be dangerous for inexperienced pilots. Any operator should be properly trained before operating vehicle to ensure their safety as well as others. Remember that parts can be damaged during flight and in storage, so it is crucial to do pre and post check flights to ensure their reliability. Please follow all instruction in this manual to properly and safely fly the vehicle.

## REFERENCES

- [1] "Instruction Manual". , 1993. Senior Telemaster Plus ARF. Hobby Lobby International, Inc. Web. 3 Apr. 2015. <http://www.hobbyexpress.com/images,empl/manuals/HLA008Manual.pdf>.
- [2] "INSTRUCTION MANUAL for Futaba 6J-2.4GHz." , Futaba Corporation. Web. 3 Apr. 2015. <http://manuals.hobbico.com/fut/6j-manual.pdf>.
- [3] "Intellegent Digital Balance Charger V6AC Operating Manual." Web. 3 Apr. 2015. <http://www.ev-peak.com/upfiles/image/specification/V6AC.pdf>.
- [4] "Mission Planner." Mission Planner. Ardupilot, n.d. Web. 03 Apr. 2015. <http://planner.ardupilot.com/>.
- [5] "ArduCopter." ArduCopter. Mission Planner, n.d. Web. 03 Apr. 2015. <http://copter.ardupilot.com/wiki/common-appendix/common-table-of-contents/>.
- [6] "ArduPlane." ArduPlane. Mission Planner, n.d. Web. 03 Apr. 2015. <http://plane.ardupilot.com/wiki/common-appendix/common-table-of-contents/>.
- [7] "3DR RADIOV2 QUICK START GUIDE." 3DRobotics. 3DRobotics. Web. <http://3drobotics.com/wp-content/uploads/2013/10/3DR-Radio-V2-doc1.pdf>.
- [8] "Battery Basics: A Layman's Guide to Batteries." Battery Basics: A Layman's Guide to Batte. BatteryStuff.com, n.d. Web. 03 Apr. 2015. <http://www.batterystuff.com/kb/articles/battery-articles/battery-basics.html>.